

# Photomicrosensor (Reflective) EE-SF5(-B)

## ■ Dimensions

Note: All units are in millimeters unless otherwise indicated.

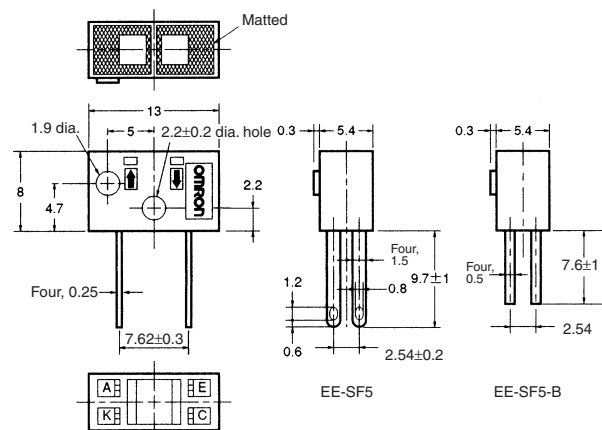

### Internal Circuit

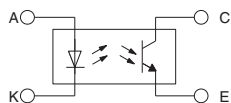

Unless otherwise specified, the tolerances are as shown below.

Dimensions	Tolerance
3 mm max.	±0.3
3 < mm ≤ 6	±0.375
6 < mm ≤ 10	±0.45
10 < mm ≤ 18	±0.55
18 < mm ≤ 30	±0.65

Terminal No.	Name
A	Anode
K	Cathode
C	Collector
E	Emitter

## ■ Features

- Dust-tight construction.
- With a visible-light intercepting filter which allows objects to be sensed without being greatly influenced by the light radiated from fluorescent lamps.
- Mounted with M2 screws.
- Model with soldering terminals (EE-SF5).
- Model with PCB terminals (EE-SF5-B).
- RoHS Compliant.

## ■ Absolute Maximum Ratings (Ta = 25°C)

Item	Symbol	Rated value
Emitter	Forward current	$I_F$ 50 mA (see note 1)
	Pulse forward current	$I_{FP}$ 1 A (see note 2)
	Reverse voltage	$V_R$ 4 V
Detector	Collector–Emitter voltage	$V_{CEO}$ 30 V
	Emitter–Collector voltage	$V_{ECO}$ ---
	Collector current	$I_C$ 20 mA
	Collector dissipation	$P_C$ 100 mW (see note 1)
Ambient temperature	Operating	$T_{opr}$ -25°C to 80°C
	Storage	$T_{stg}$ -30°C to 80°C
Soldering temperature	$T_{sol}$	260°C (see note 3)

- Note: 1. Refer to the temperature rating chart if the ambient temperature exceeds 25°C.  
 2. The pulse width is 10 μs maximum with a frequency of 100 Hz.  
 3. Complete soldering within 10 seconds.

## ■ Ordering Information

Description	Model
Photomicrosensor (reflective) with soldering terminals	EE-SF5
Photomicrosensor (reflective) with PCB terminals	EE-SF5-B

## ■ Electrical and Optical Characteristics (Ta = 25°C)

Item	Symbol	Value	Condition
Emitter	Forward voltage	$V_F$ 1.2 V typ., 1.5 V max.	$I_F = 30$ mA
	Reverse current	$I_R$ 0.01 μA typ., 10 μA max.	$V_R = 4$ V
	Peak emission wavelength	$\lambda_p$ 940 nm typ.	$I_F = 20$ mA
Detector	Light current	$I_L$ 200 μA min., 2,000 μA max.	$I_F = 20$ mA, $V_{CE} = 10$ V White paper with a reflection ratio of 90%, d = 5 mm (see note)
	Dark current	$I_D$ 2 nA typ., 200 nA max.	$V_{CE} = 10$ V, 0 lx
	Leakage current	$I_{LEAK}$ 2 μA max.	$I_F = 20$ mA, $V_{CE} = 10$ V with no reflection
	Collector–Emitter saturated voltage	$V_{CE(sat)}$	---
	Peak spectral sensitivity wavelength	$\lambda_p$ 850 nm typ.	$V_{CE} = 10$ V
Rising time	$t_r$	30 μs typ.	$V_{CC} = 5$ V, $R_L = 1$ kΩ, $I_L = 1$ mA
Falling time	$t_f$	30 μs typ.	$V_{CC} = 5$ V, $R_L = 1$ kΩ, $I_L = 1$ mA

Note: The letter “d” indicates the distance between the top surface of the sensor and the sensing object.

■ Engineering Data

Forward Current vs. Collector Dissipation Temperature Rating

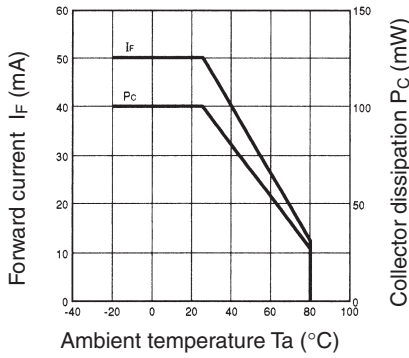

Relative Light Current vs. Ambient Temperature Characteristics (Typical)

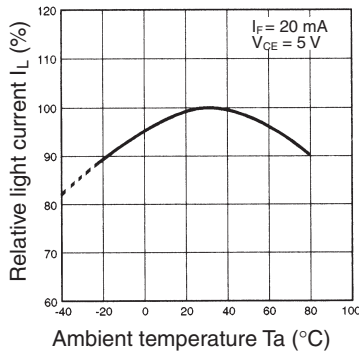

Sensing Distance Characteristics (Typical)

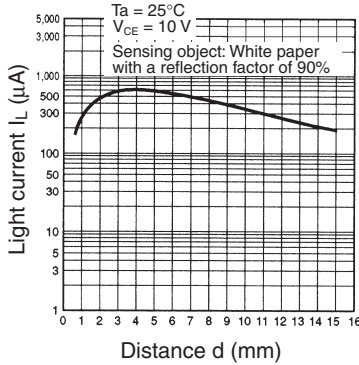

Sensing Angle Characteristics (Typical)

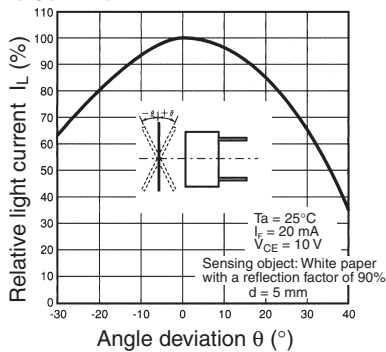

Light Current vs. Forward Current Characteristics (Typical)

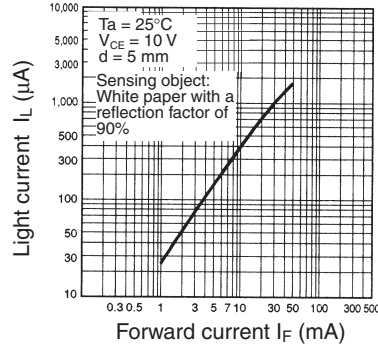

Dark Current vs. Ambient Temperature Characteristics (Typical)

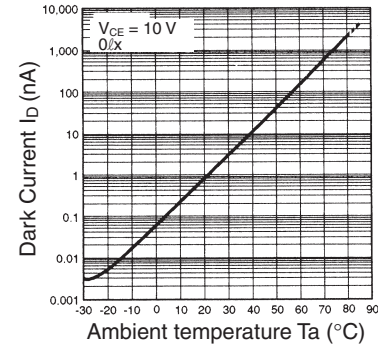

Sensing Position Characteristics (Typical)

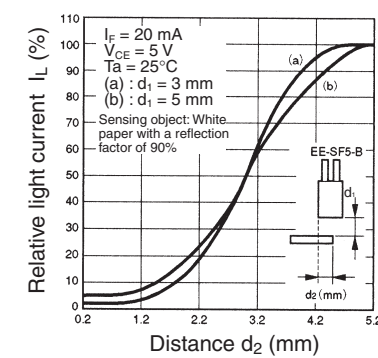

Sensing Angle Characteristics (Typical)

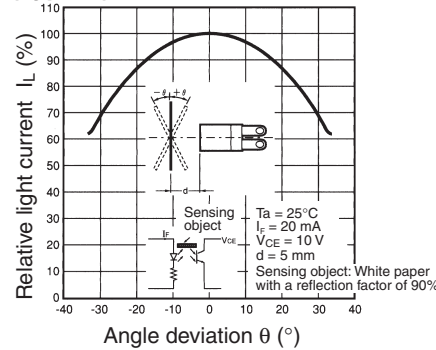

Light Current vs. Collector-Emitter Voltage Characteristics (Typical)

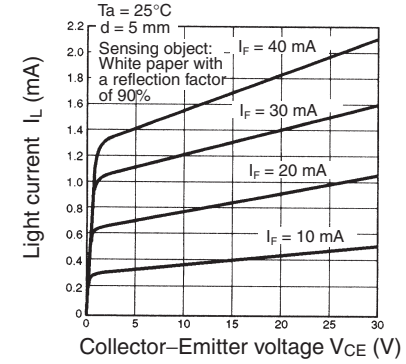

Response Time vs. Load Resistance Characteristics (Typical)

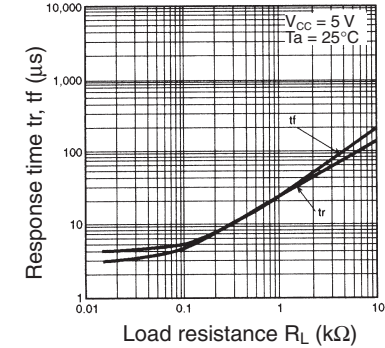

Sensing Position Characteristics (Typical)

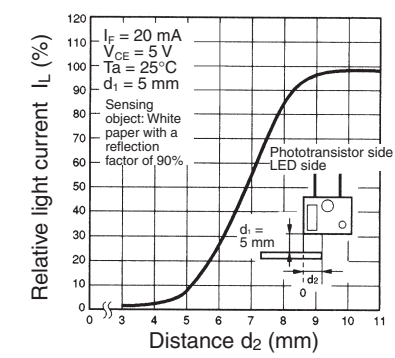

Response Time Measurement Circuit

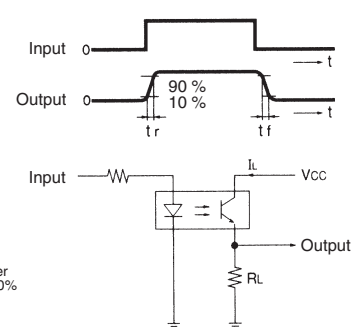



All sales are subject to Omron Electronic Components LLC standard terms and conditions of sale, which can be found at [http://www.components.omron.com/components/web/webfiles.nsf/sales\\_terms.html](http://www.components.omron.com/components/web/webfiles.nsf/sales_terms.html)

**ALL DIMENSIONS SHOWN ARE IN MILLIMETERS.**  
To convert millimeters into inches, multiply by 0.03937. To convert grams into ounces, multiply by 0.03527.

---

**OMRON**<sup>®</sup>

**OMRON ELECTRONIC  
COMPONENTS LLC**

55 E. Commerce Drive, Suite B  
Schaumburg, IL 60173

**847-882-2288**

**OMRON ON-LINE**

Global - <http://www.omron.com>

USA - <http://www.components.omron.com>